

A man with short brown hair and a focused expression is shown from the chest up, wearing a blue tank top. He is using a gym machine, with his hands on a handle. The background is a plain, light-colored wall. The image is framed by a large, diagonal orange shape on the right side.

*Assembly &  
Owner's Guide*



**ST770**  
**BICEP/TRICEP**



# *Table of Contents*

## **ASSEMBLY GUIDE**

ASSEMBLY GUIDE .....	4
HARDWARE BAGS .....	6
STEP 1: ORANGE BAG .....	11
STEP 2: BLUE BAG .....	12
STEP 3: PINK BAG .....	13
STEP 4: GREEN BAG .....	14
STEP 5: BLACK BAG .....	15
STEP 6: YELLOW BAG .....	16
STEP 7: RED BAG .....	17
STEP 8: LIGHT BLUE BAG .....	18

## **OWNER'S GUIDE**

RESISTANCE TRAINING BENEFITS & TIPS, WORKOUT VARIATIONS .....	20
TRAINING PROGRAMS .....	21
STRETCHING .....	22
MAINTENANCE SCHEDULE .....	24
COMMERCIAL WARRANTY .....	25
WORKOUT LOGS .....	26

# *Assembly & Owner's Guide*

## **ST770 BICEP/TRICEP**

To avoid possible damage to this Bicep/Tricep, please follow these assembly steps in the correct order. Before proceeding, find your new Bicep/Tricep serial number located on the back of the main floor support (AC1), and enter here:

---

Refer to this number when calling for service, and enter this serial number on your Warranty Card and in your own records. Be sure to read your Owner's Guide before using your new Bicep/Tricep.  
If any parts, hardware or tools are missing, please call 1.800.335.4348, Extension 12

***NOTE: During assembly, it is recommended to ensure that all bolts are in place and partially threaded before completely tightening any one bolt. During assembly steps 1 thru 4, do not completely tighten any bolts until completion of Step 4.***

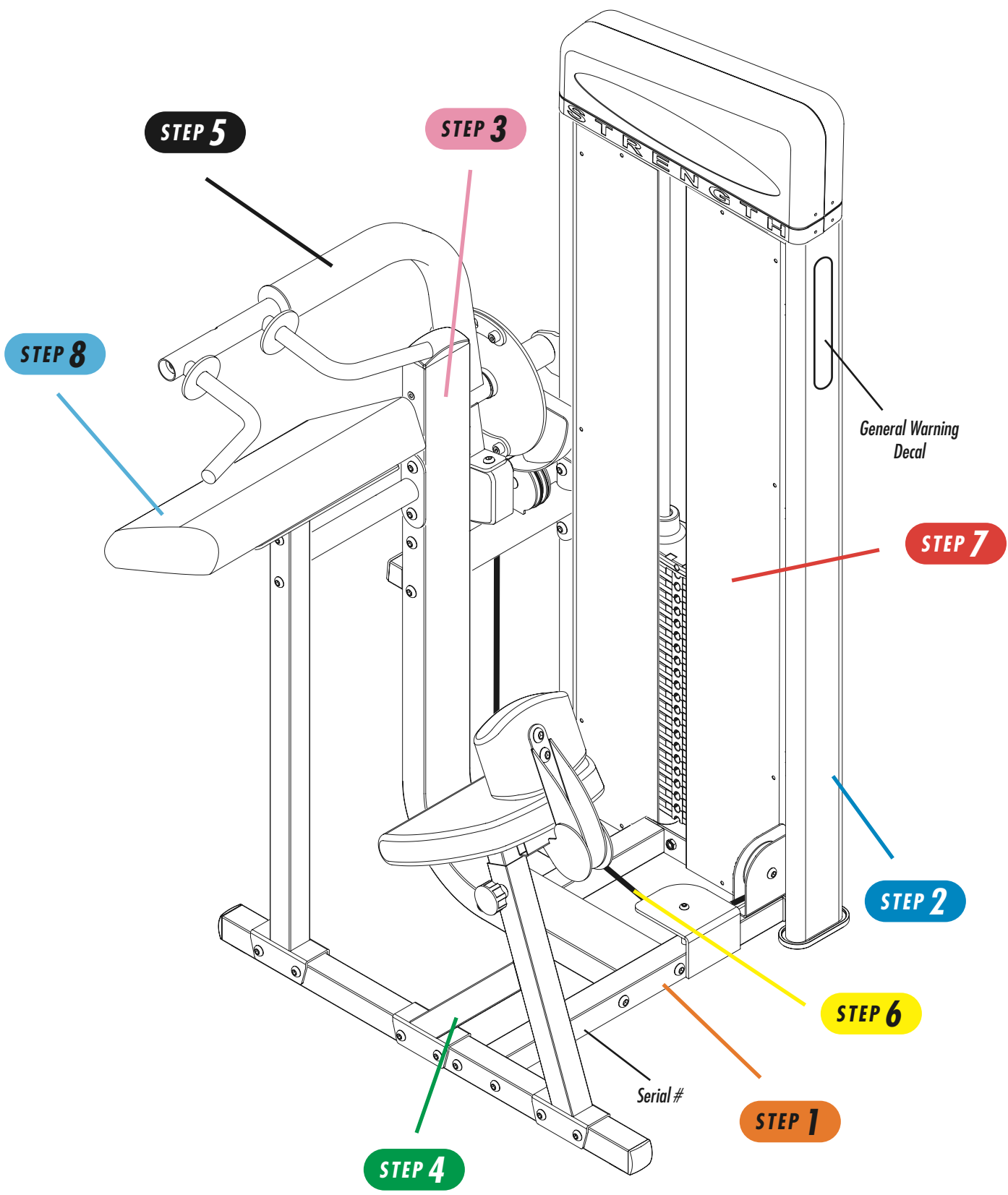

# HARDWARE INCLUDED

## ORANGE BAG

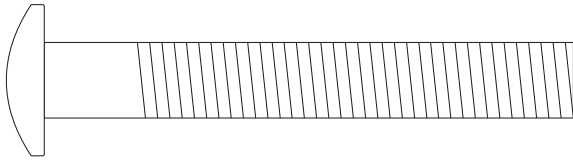
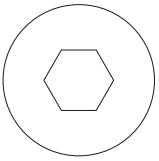

M10 x 70 Bolt  
Quantity: 5

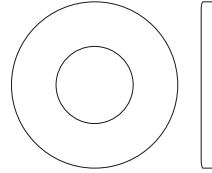

10.2 x 22 x 2  
Flat Washer  
Quantity: 14

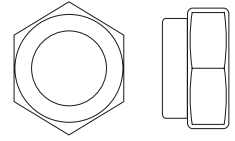

M10 Nylon Nut  
Quantity: 7

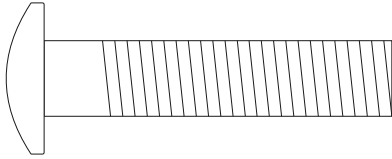
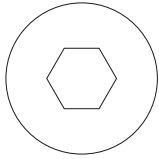

M10 x 46 Bolt  
Quantity: 2

## BLUE BAG

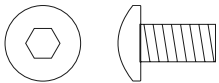

M5 x 10 Bolt  
Quantity: 20

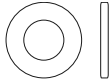

5.3 x 10 x 1  
Flat Washer  
Quantity: 20



5.1 x 9.3 x 1.3  
Lock Washer  
Quantity: 20

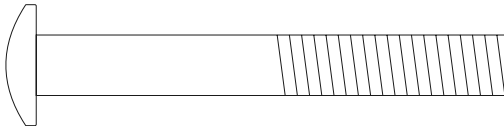
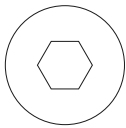

M8 x 62 Bolt  
Quantity: 2

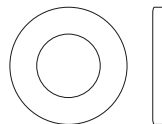

8.4 x 15.5 x 1.6  
Flat Washer  
Quantity: 4

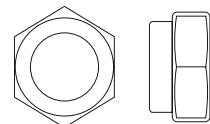

M8 Nylon Nut  
Quantity: 2

# HARDWARE INCLUDED

## PINK BAG

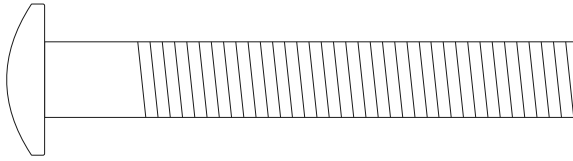
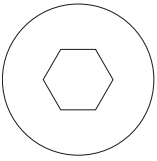

M10 x 70 Bolt  
Quantity: 2

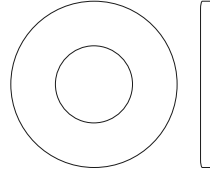

10.2 x 22 x 2  
Flat Washer  
Quantity: 16

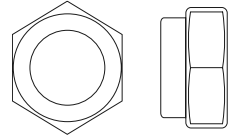

M10 Nylon Nut  
Quantity: 8

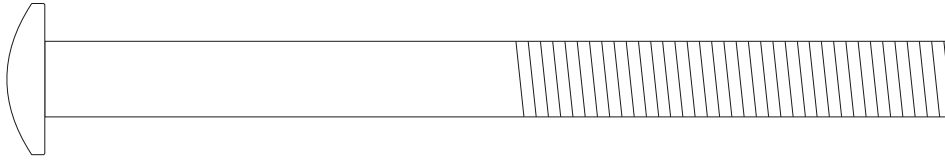
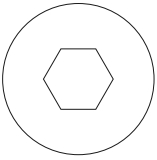

M10 x 120 Bolt  
Quantity: 4

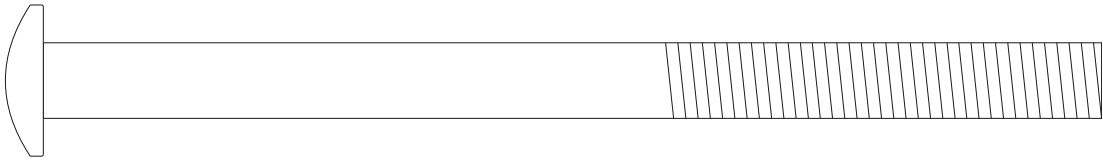
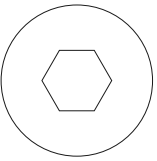

M10 x 140 Bolt  
Quantity: 2

# HARDWARE INCLUDED

## GREEN BAG

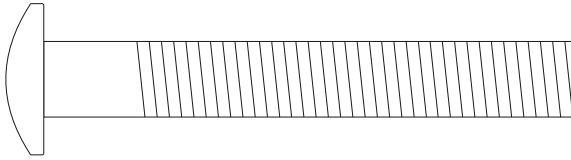
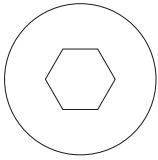

M10 x 70 Bolt  
Quantity: 2

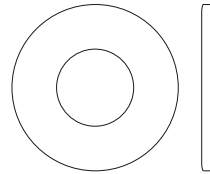

10.2 x 22 x 2  
Flat Washer  
Quantity: 20

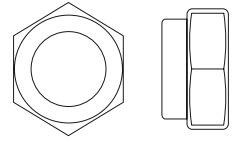

M10 Nylon Nut  
Quantity: 10

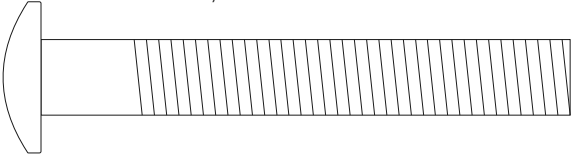
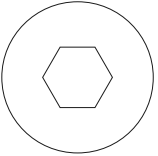

M10 x 75 Bolt  
Quantity: 6

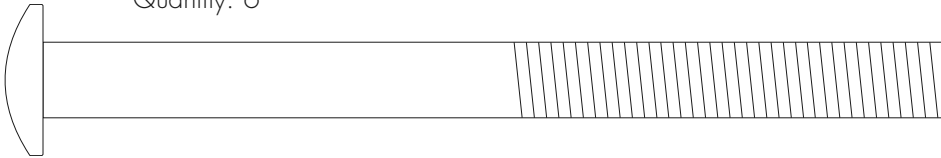
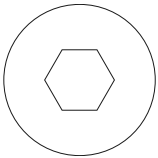

M10 x 120 Bolt  
Quantity: 2



# HARDWARE INCLUDED

## BLACK BAG

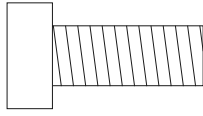
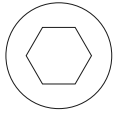

M8 x 20 Bolt  
Quantity: 1

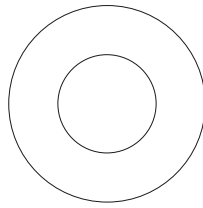

13 x 26 x 2.5  
Flat Washer  
Quantity: 2

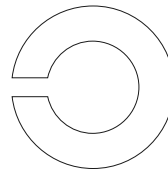

12.2 x 21 x 3  
Lock Washer  
Quantity: 2

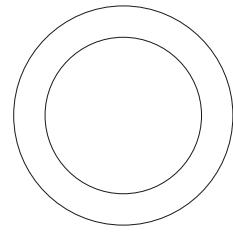

20.7 x 29.1 x 0.3  
Wavy Washer  
Quantity: 1

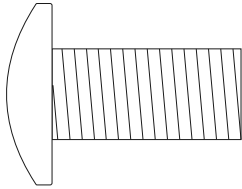
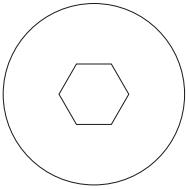

M12 x 25 Bolt  
Quantity: 2

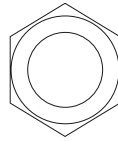

M10 Nylon Nut  
Quantity: 2

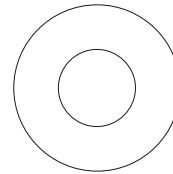

10.2 x 22 x 2  
Flat Washer  
Quantity: 6

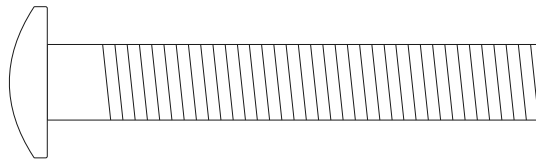
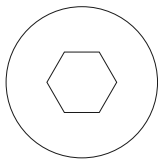

M10 x 65 Bolt  
Quantity: 2

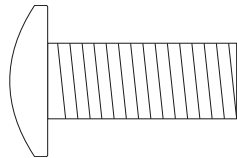
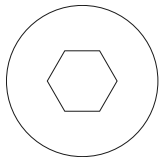

M10 x 25 Bolt  
Quantity: 2

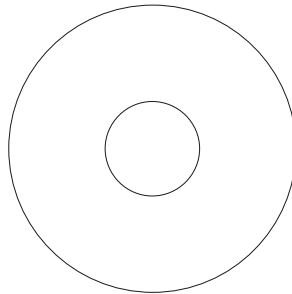

12.5 x 38 x 3  
Flat Washer  
Quantity: 1

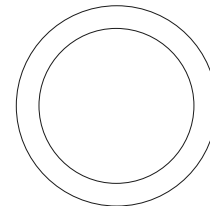

20.5 x 26.5 x 4  
Flat Washer  
Quantity: 1

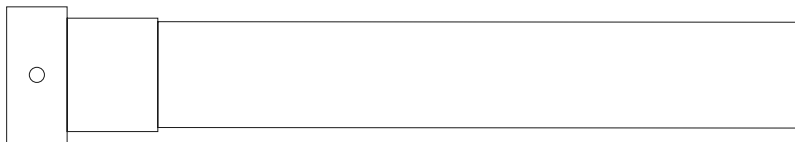

297mm Axle  
*illustration not to scale*  
Quantity: 1

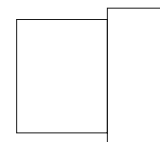

Bushing  
*illustration not to scale*  
Quantity: 1

# HARDWARE INCLUDED

## YELLOW BAG

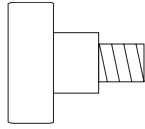
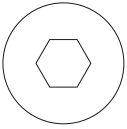

M8 x 12 Shoulder Bolt  
Quantity: 1

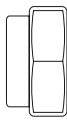
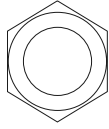

M8 Nylon Nut  
Quantity: 1

## RED BAG

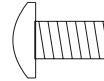

M5 x 10 Bolt  
Quantity: 18



Slip-On Nut  
*illustration not to scale*  
Quantity: 2

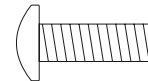

M5 x 15 Bolt  
Quantity: 6

## LIGHT BLUE BAG

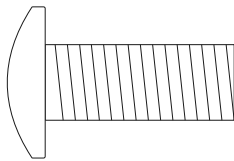
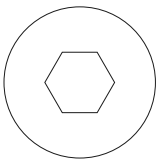

M10 x 25 Bolt  
Quantity: 6

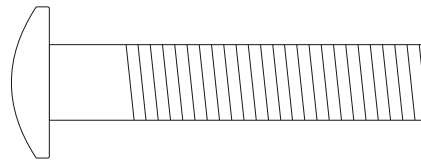
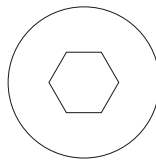

M10 x 50 Bolt  
Quantity: 4

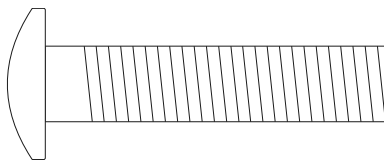
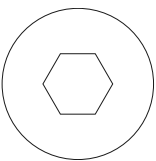

M10 x 45 Bolt  
Quantity: 4

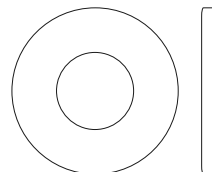

10.2 x 22 x 2  
Flat Washer  
Quantity: 12

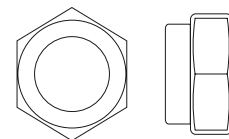

M10 Nylon Nut  
Quantity: 4

**STEP 1****ORANGE BAG**

**NOTE:** During assembly, it is recommended to ensure that all bolts are in place and partially threaded before completely tightening any one bolt. During assembly steps 1 thru 5, do not completely tighten any bolts until completion of Step 5.

- Lay the main floor support (AC1) on the ground, pulley brackets facing up. Place the end opposite of the pulley brackets against the side of the left floor support (AC5). Align the main floor support holes with the 3rd and 4th holes from the end of the left floor support. Secure using two bolts (M10x70), four flat washers (10.2x22x2), and two nylon nuts (M10).

- Stand the weight stack tower (AB1) upright and place the previously assembled floor supports (AC1 & AC5) up against holes in the tower. Slide three bolts (M10x70) with three flat washers (10.2x22x2) through the holes, securing the bolts with three more flat washers and three nylon nuts (M10).

- Attach two pulleys to weight stack using a bolt (M10x46), two flat washers (10.2x22x2), and a nylon nut (M10) for each pulley.

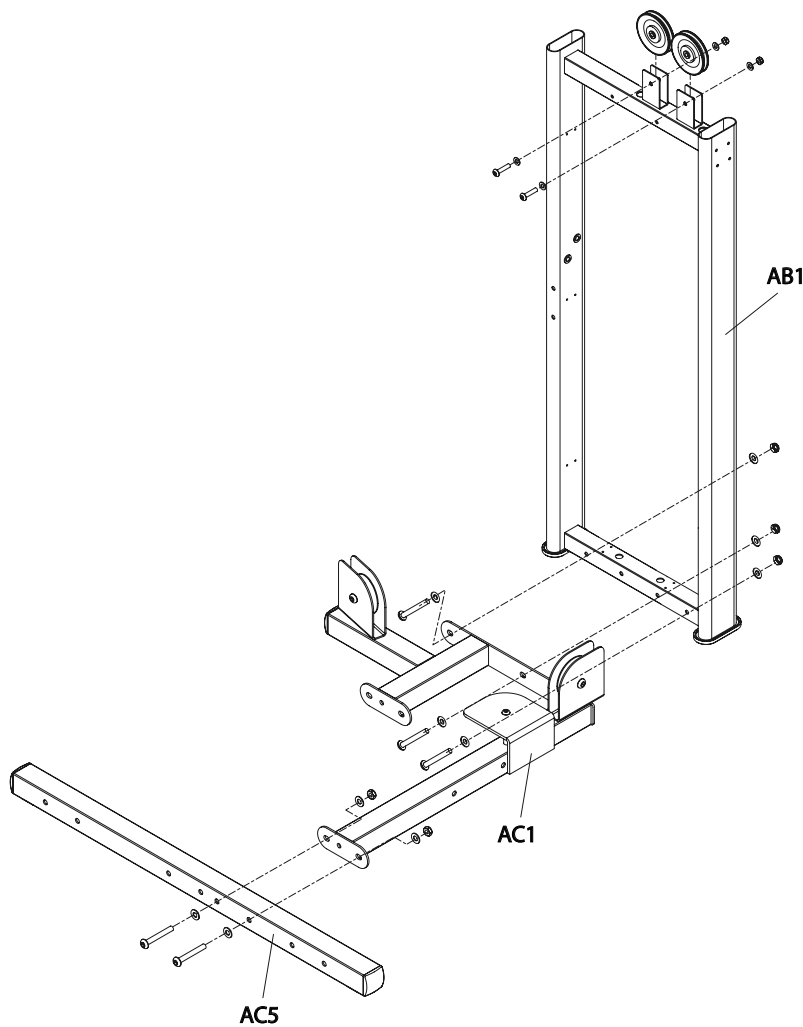

**STEP 2****BLUE BAG**

- Loosely secure top and bottom shield brackets to weight stack tower using eight bolts (M5x10), eight lock washers (5.1x9.3x1.3), and eight flat washers (5.3x10x1) provided. Repeat for all side brackets.

- Place two rubber weight plate bumpers over the holes in the lower cross tube of the weight stack tower. With the horizontal holes of the guide rods at the top, place them over and through the rubber weight plate bumpers into the weight stack tower. Let the guide rods tilt outward from the tower. Slide each of the 15 weight plates over both of the guide rods on top of one another. Place the header weight plate over both guide rods on top of other weight plates.

- Make sure rubber guide rod sleeves are in place in top holes of the weight stack tower. Lift the guide rods into top of weight stack tower until holes in the guide rod are lined up with the horizontal holes on the top of the weight stack tower. Insert a bolt (M8x62) with a flat washer (8.4x15.5x1.6) through each guide rod and fasten with another flat washer and nylon nut (M8).

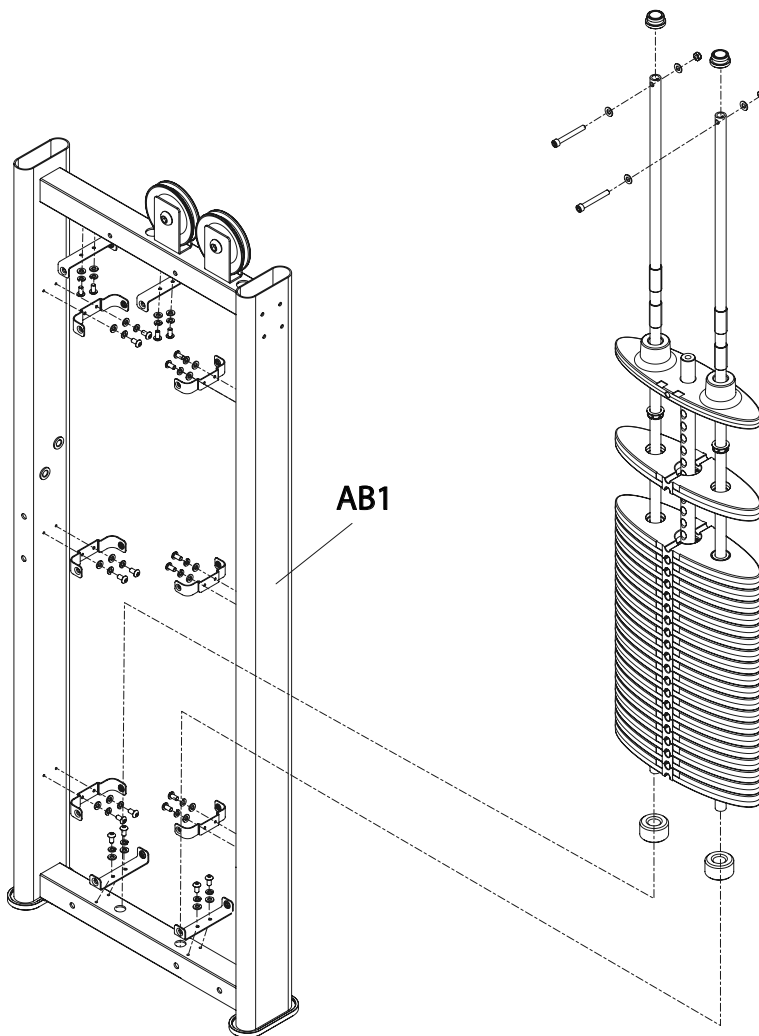

**STEP 3****PINK BAG**

- Set the swing arm support (AC4) against the remaining holes in the side of the main floor support (AC1) and secure using two bolts (M10x70), four flat washers (10.2x22x2) and two nylon nuts (M10). Secure the connection in front of the weight stack with two bolts (M10x120), four flat washers (10.2x22x2), and two nylon nuts (M10).

- Place the dual pulley bracket (AG1) in between holes on the swing arm support (AC4) and the weight stack tower (AB1). Use two bolts (M10x120), four flat washers (10.2x22x2), and two nylon nuts (M10) to secure the swing arm support side of the bracket. Use two bolts (M10x140), four flat washers and two nylon nuts, respectively, to secure weight stack tower side.

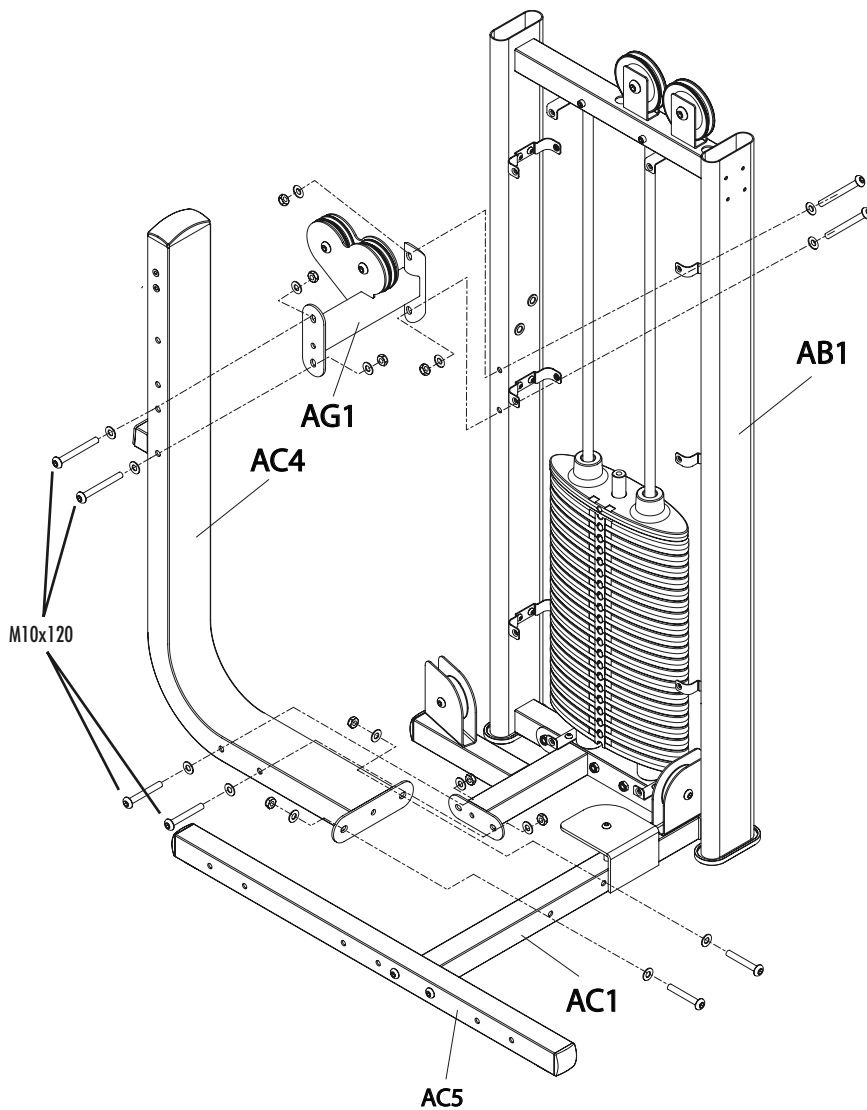

**STEP 4****GREEN BAG**

- Slide the bracket of the arm pad support (AC2) over the left floor support (AC5), aligning the holes in both pieces. Make sure the pad plate is facing forward of the machine. See diagram for clarification. Secure using two bolts (M10x75), four flat washers (10.2x22x2), and two nylon nuts (M10).

- Place the connecting brace (AG2) between the arm pad support (AC2) and swing arm support (AC4), aligning holes on both sides. On the arm pad support side, use two bolts (M10x70), four flat washers (10.2x22x2), and two nylon nuts (M10) to secure. On the swing arm support side, use two bolts (M10x120), four more flat washers, and two more nylon nuts.

- Take the main seat support (AC3) and place over the remaining holes in the left floor support (AC5). Connect using four bolts (M10x75), eight flat washers (10.2x22x2), and four nylon nuts (M10).

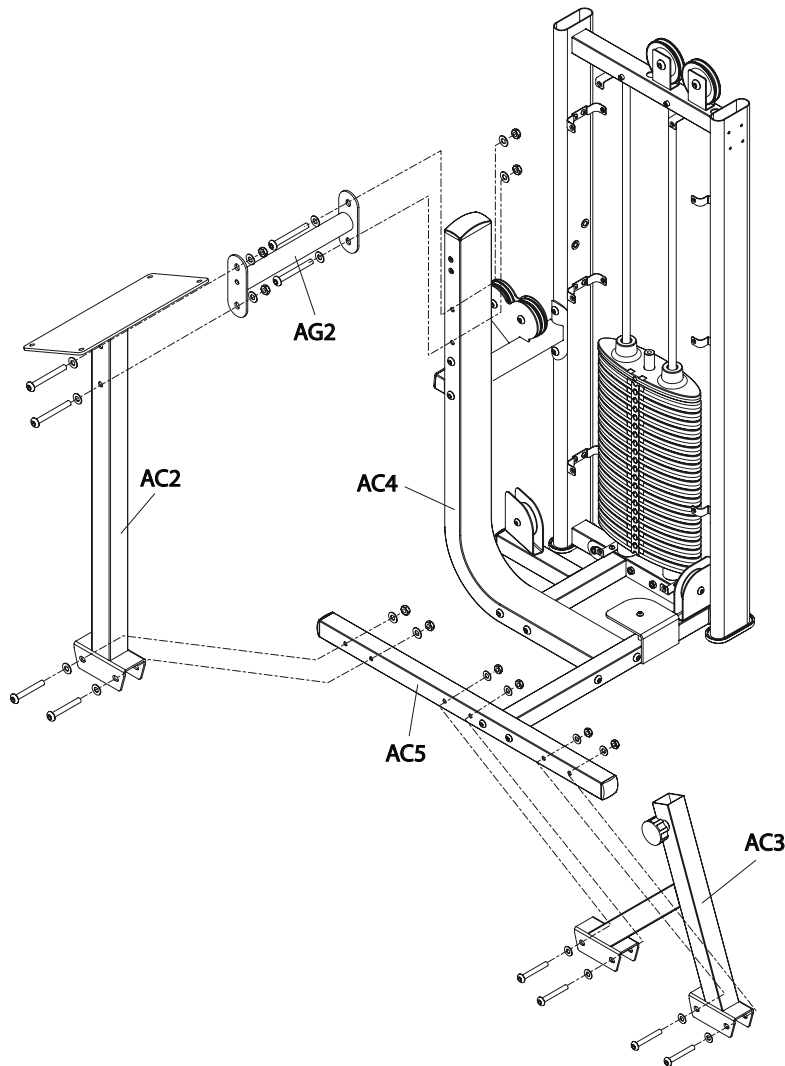

**STEP 5****BLACK BAG**

- Attach the weight stack tower bracket (Z35) to the weight stack tower using two bolts (M10x65), four flat washers (10.2x22x2), and two nylon nuts (M10).

- To attach the swing arm (AF3) and range of motion plate (AF1), slide the 297mm axle through hole in bracket on swing arm support (AC4). Slide on a flat washer (20.5x26.5x4), swing arm, wavy washer (20.7x29.1x0.3), and range of motion plate, in that order. The axle should then go through the weight stack tower bracket and be secured with a bushing, flat washer (13x26x2.5), lock washer (12.2x21.5x3), and bolt (M12x25). Make sure the flats on the axle match up with those on the brackets.

- Slide the workout handle (AE1) onto the shaft of the swing arm (AF3) and secure using a large flat washer (12.5x38x3), a flat washer (13x26x2.5), a lock washer (12.2x21.5x3), and a bolt (M12x25). Lifting the handle slightly will reveal an opening in the shaft that a bolt (M8x20) can be threaded into to prevent the workout handle from flopping around dangerously. Attach the counterweight to the swing arm using two bolts (M10x25) and two flat washers (10.2x22x2). Tighten all hardware. Make sure the swing arm axle is level after hardware is tightened.

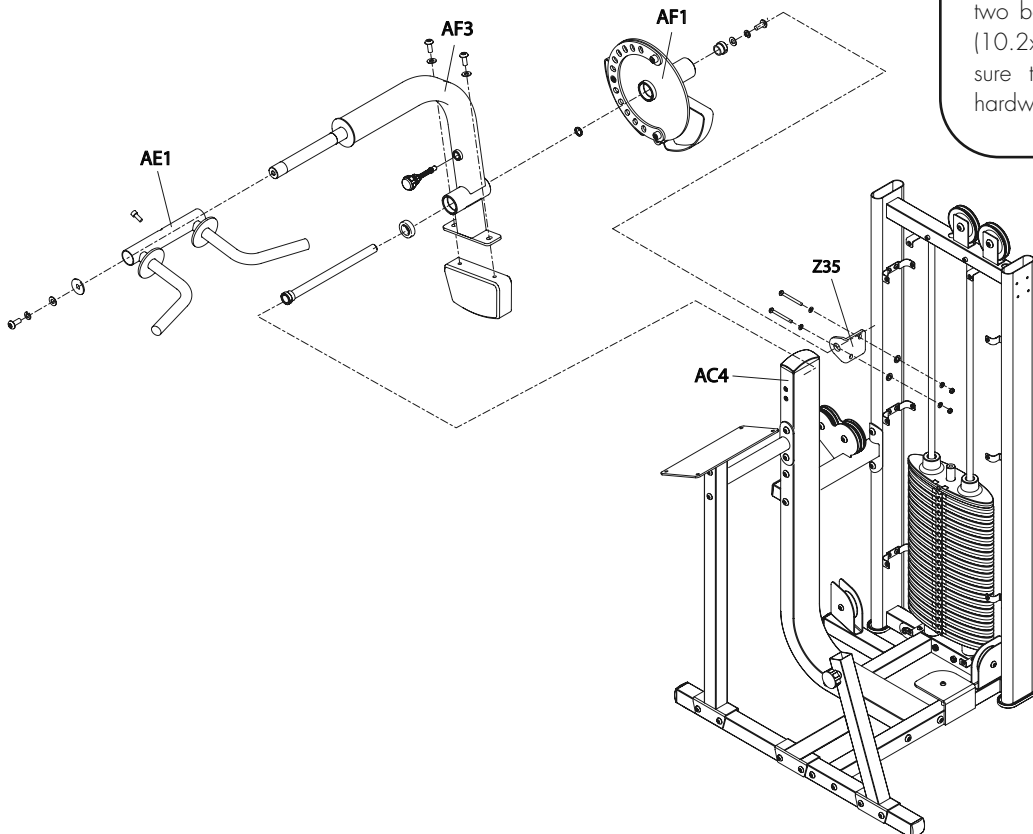

## STEP 6

## YELLOW BAG

- With the loop end of the cable in your hand, guide the cable through the hole in top of the weight stack tower (AB1) and around pulleys A and B. Go through other hole in weight stack tower and all the way down and around pulley C. Now guide the cable around pulleys D (loosen pulley D and make sure cable is routed between the post and the pulley) and E and through pulleys F and G. Attach loop end into the range of motion plate (AF1) by sliding a shoulder bolt (M8x12) through the bracket and loop. Secure with a nut(M8).

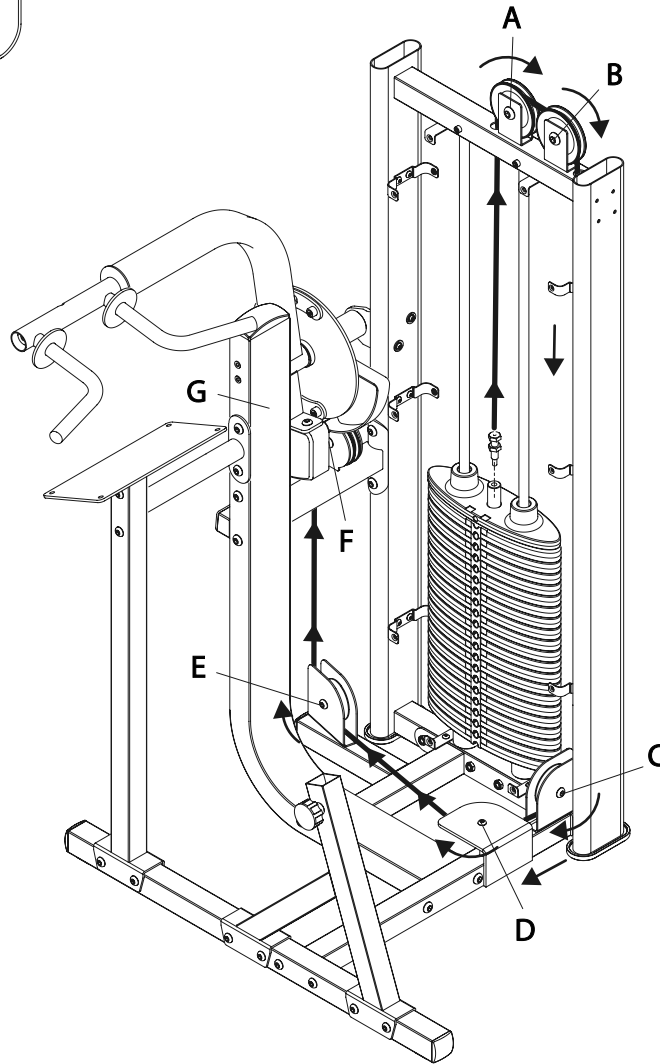
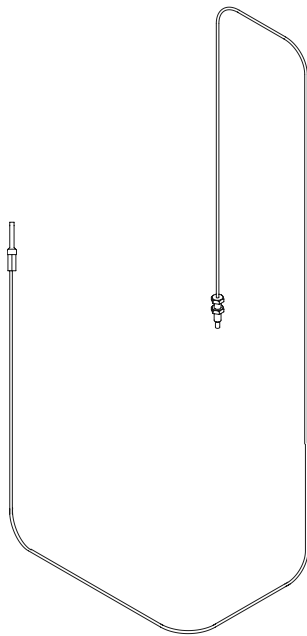



**STEP 7****RED BAG**

- Align holes in rear shield with the holes in the brackets on the back side of the weight stack; loosely secure using 8 bolts (M5x10). Take the left side shield and repeat on front side of weight stack tower using five bolts (M5x10). Tighten interior brackets. Repeat for the right side shield. Tighten all bolts.

- Attach two slip on nuts (Z39) to the left side of the weight stack tower (AB1). Snap two halves of top cover (Q06 & Q07) together. With tallest point facing the rear of the machine, place the assembled top covers on top of the weight stack tower and secure using six bolts (M5x15).

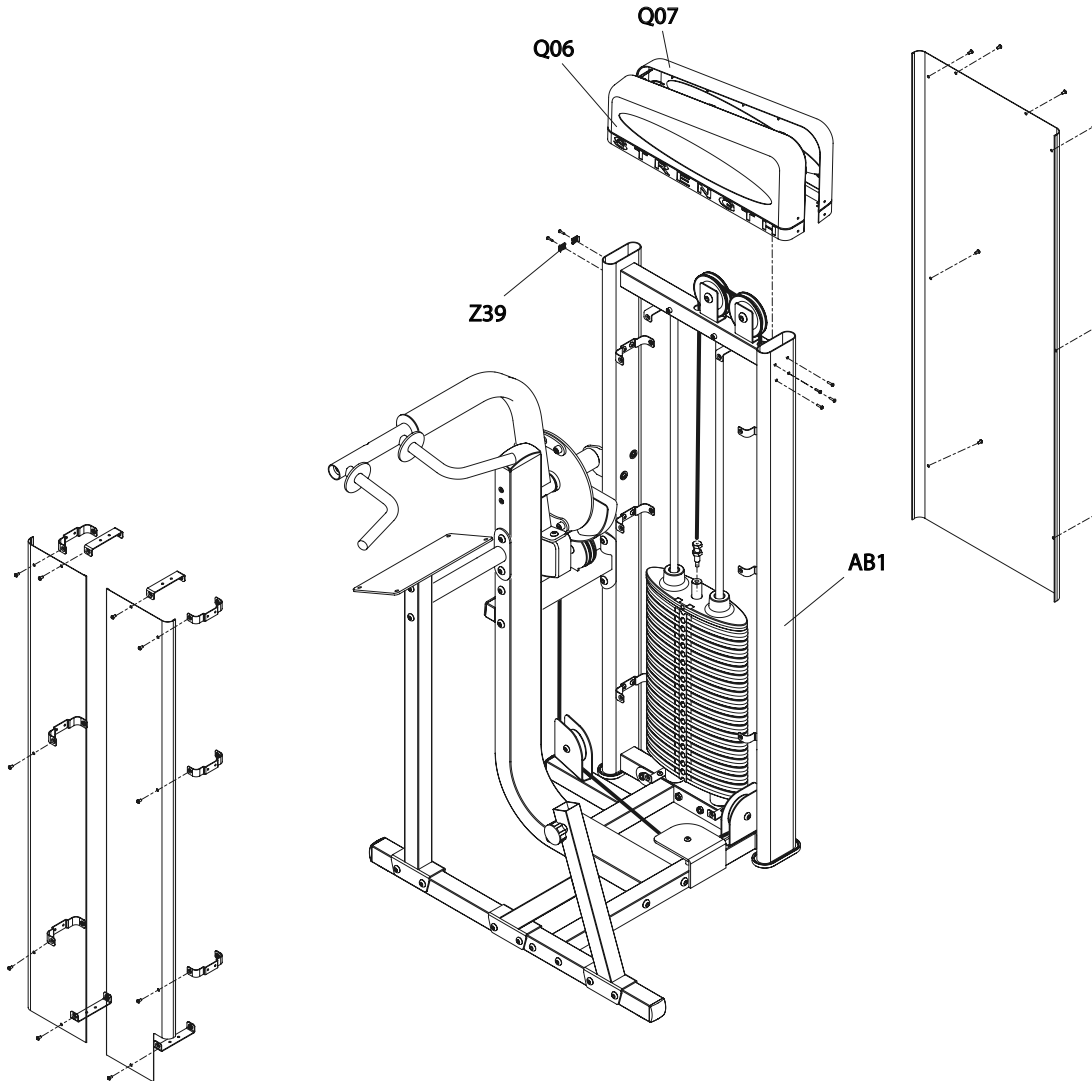

**STEP 8****LIGHT BLUE BAG**

- Attach arm pad to arm pad support (AC2) using four bolts (M10x25).
- Attach the seat post (AT1) to the seat bracket by sliding four bolts (M10x45) and four flat washers (10.2x22x2) through the bracket. Fasten four more flat washers (10.2x22x2) and four nylon nuts (M10) on the bottom.
- Take the seat post assembly (AT1) and attach the seat bottom using four bolts (M10x50) and four flat washers (10.2x22x2). Attach seat back to the support using two bolts (M10x25). Disengage the pull pin and slide the completed assembly into the main seat support (AC3). Secure by tightening the pull pin.

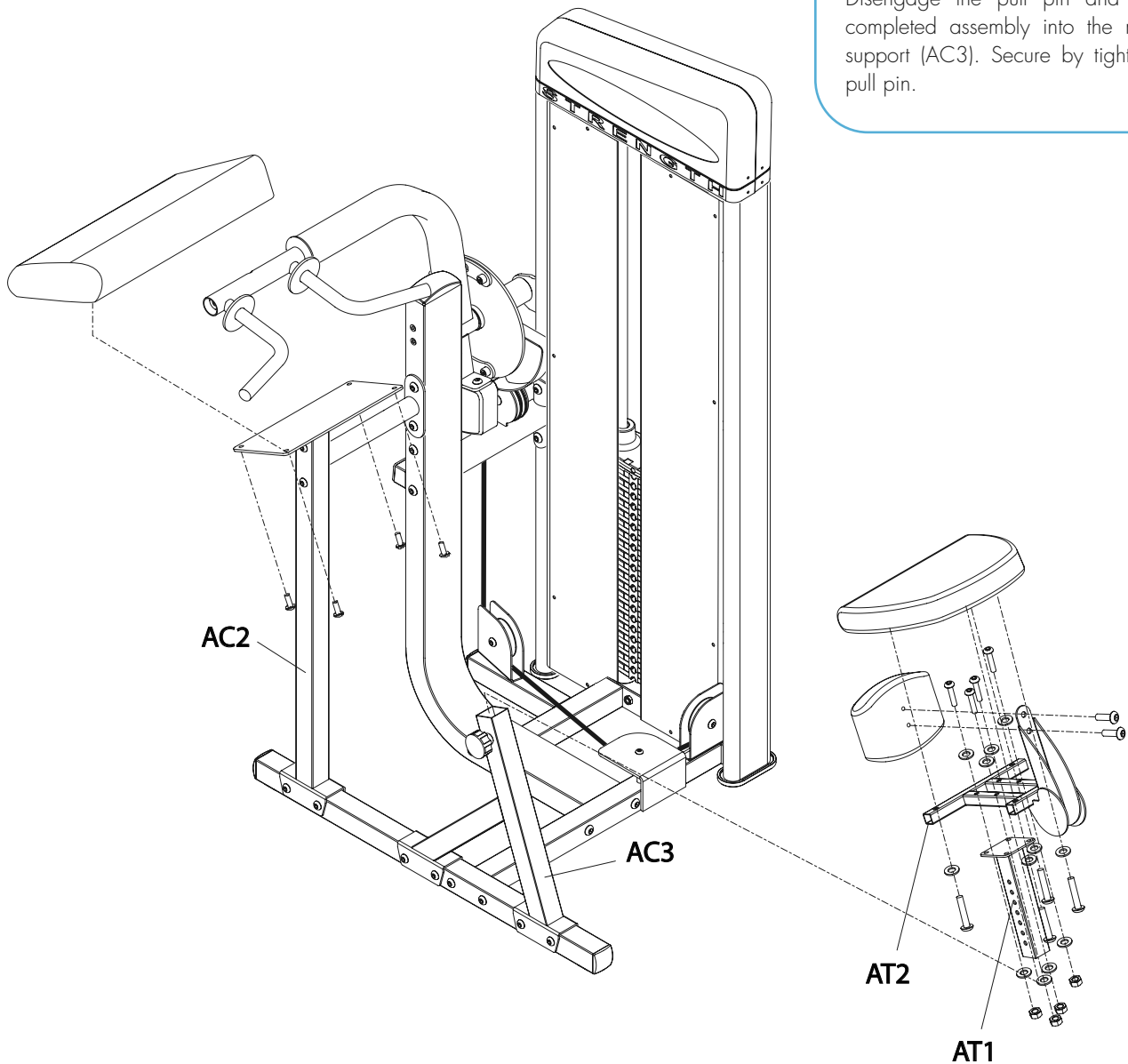



## **RESISTANCE TRAINING BENEFITS AND TIPS**

Always consult a physician before starting an exercise program.

To be successful in your exercise program, it is important to develop an understanding of the basic principles of resistance training. Now that you have assembled your VISION FITNESS gym, it is only natural that you want to get started immediately. First, determine a few realistic, short term goals and expectations for yourself. Choose an appropriate exercise routine that best suits your individual needs. Any of the 3 programs, explained in the Training Programs section below, is a great starting point.

Warm up properly before engaging in resistance training. Stretching, yoga, jogging, calisthenics, or other cardiovascular exercise can help prepare your body for the heavier workload of lifting weights.

Learn how to perform the exercise correctly before using heavy weight. Correct form is important to avoid injury and ensure that you work the proper muscle groups.

Know your limitations. If you are new to resistance training or are starting back, after an extended layoff, start slowly and build foundational strength over a longer period of time.

Pay attention to your breathing. As a general rule of thumb: inhale on the non-exertion part of the movement and exhale during the exertion portion. Never hold your breath.

Keep in mind how important the recovery phase is in achieving your goals. The general rule is to allow a minimum of 48-72 hours before training the same muscle/s. If you still experience soreness after this period of time has elapsed, take a few additional days until the soreness has subsided.

Use this manual to guide you through the basic exercises you can perform on your VISION FITNESS gym. To achieve maximum results and avoid possible injury, consult a fitness professional to formulate a complete exercise program.

### **WORKOUT VARIATIONS**

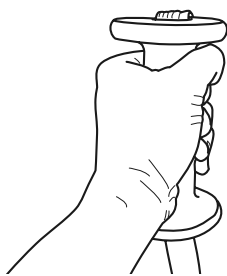

**NEUTRAL GRIP**

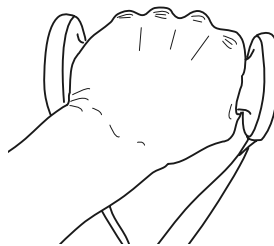

**OVERHAND OR PRONATED GRIP**

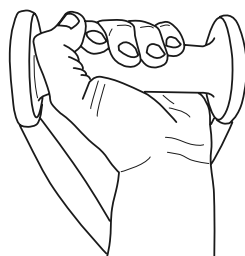

**UNDERHAND OR SUPINATED GRIP**

## **TRAINING PROGRAMS**

### **MUSCULAR ENDURANCE**

A program that stresses moderate intensity, a lower amount of resistance, and higher repetitions (anywhere from 13-100 or more). These types of sets will take longer to complete. This type of training conditions the muscles for activities that stress the slow twitch muscle fibers of your body. This is beneficial for sustaining energy over moderate periods of time.

### **MUSCULAR STRENGTH**

A program that stresses high intensity, a higher amount of resistance, and lower repetitions (anywhere from 6-12). These types of sets will take a shorter period of time to complete. This type of training conditions the muscles for activities that stress the fast twitch muscle fibers of the body. This is beneficial for activities that require short bursts of speed and power.

### **SPRINT 8**

This program is exclusive to VISION FITNESS exercise equipment. This is a program that stresses high intensity, a moderate amount of resistance, and as many repetitions that a person can perform in a specified period of time (usually 20-30 seconds). This program works especially well for the time crunched exerciser. It allows you to work both the slow and fast twitch muscle fibers of the body. This program gives you a good cardiovascular and strength workout. The thing that is most appealing about this program is that an individual can complete it in 20 minutes.

This is how the program works:

The person picks the number of exercises they want to perform. Examples would be 1, 2, 4, or 8 exercises. The individual completes a 3 minute warm up with a brisk walk or on a piece of cardiovascular equipment. After the warm up is complete, the user begins performing the first exercise maintaining a high intensity pace throughout the determined amount of time (20-30 seconds). After this period of time, the individual can perform an active, low intensity recovery phase, stretching, or complete rest. This should last 1.5-2 minutes or less, if you are at a higher fitness level. After the recovery phase, the individual performs the second high intensity exercise for the required amount of time (20-30 seconds). This is followed by the second recovery phase. This process repeats until you are done with 8 high intensity intervals. Finish the workout by completing a 3-5 minute very low intensity cool down.

## STRETCHING

Flexibility Training is not associated with fitness as often as cardiovascular exercise or Strength Training, even though it is just as important. A good stretching program will help to maintain flexibility of the hips and lower back. A flexible person will be less likely to injure themselves in common activities, such as reaching, twisting and turning, or in uncommon activities such as the annual softball tournament.

Before stretching, take a few minutes to warm up the muscles because stretching a cold muscle can cause injury. Start your stretch slowly, exhaling as you gently stretch the muscle. Try to hold each stretch 15 to 30 seconds. Don't bounce when you stretch. Holding a stretch offers less chance of injury. Don't strain or push a muscle too far. If it hurts, ease up. Here are a few stretches you can incorporate into your exercise program:

### SEATED TOE TOUCH (HAMSTRINGS & LOWER BACK)

Sit on the floor with your legs together and straight out in front of you. Do not lock your knees. Extend your fingers toward your toes, exhaling as you go. Hold for 15 to 30 seconds. Return to the start position, and repeat as necessary.

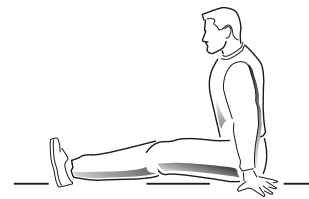

### STANDING QUADRICEPS STRETCH

Using a wall to provide balance, grasp your left ankle with your left hand and hold to stretch. Your knee should be pointing toward the floor. Hold the stretch for 15 to 30 seconds. Repeat with your right leg, and continue to alternate as necessary.

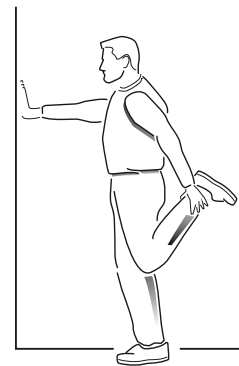

### STANDING CALF STRETCH

Standing about three to four feet from the wall, take one step forward with your right foot. Place your hands on the wall in front of you. Bend your right leg slowly, using your movement to control the amount of stretch in the left calf. Your left heel should remain on the ground. Slowly bring yourself back to the starting position and switch legs. Repeat as necessary.

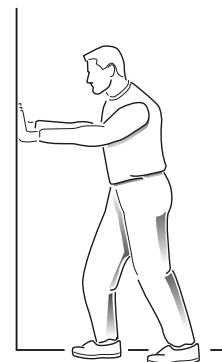

### BICEP/CHEST STRETCH

Grasp an immovable object (pole or corner of a wall) with your feet planted firmly and evenly on the floor. With the palm of your stretched side facing forward, rotate your hips away from that hand. **Be careful not to rotate too far or hyperextend the elbow joint.** Hold the stretch for 15 to 30 seconds. Repeat with the opposite side, and continue to alternate as necessary.

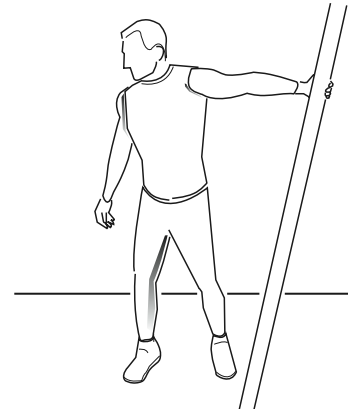

### TRICEP STRETCH

Stand erect with your eyes fixated straight ahead. Raise and bend your right arm until your forearm is parallel to the floor (palm down). Grasp the area below the right elbow with your left hand. Gently apply a constant upward force for 15 to 30 seconds. Switch arms and repeat as necessary.



### SHOULDER STRETCH

Make sure your feet are even and planted firmly on the floor. Grasp your right arm, behind the elbow, with your left hand. While keeping both elbows bent, apply a gentle, constant pull to the left for 15 to 30 seconds. Switch arms and repeat as necessary.

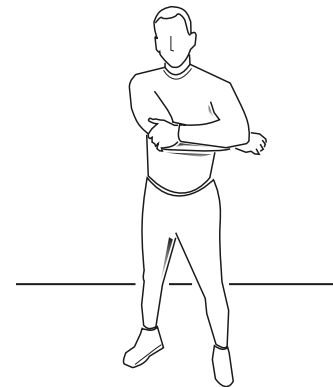

### UPPER BACK STRETCH

Stand facing an immovable object, feet even and flat on the floor. Grasp the object (fingers interlocked or one hand over the other) and slowly move your hips to the rear. **Be very careful not to round your back.** Only stretch as far as your comfort zone. Hold for 15 to 30 seconds and repeat as necessary.

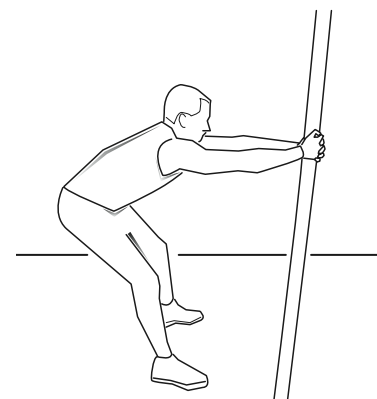

## MAINTENANCE SCHEDULE

### FOR *BEST* PERFORMANCE WE RECOMMEND THE FOLLOWING MAINTENANCE SCHEDULE:

Check the integrity and function of the following parts. Replace all worn components immediately.

<b>ITEM</b>	<b>DAILY</b>	<b>WEEKLY</b>
<b>CABLES</b> CHECK END FITTINGS AND CABLE JACKET COATING. CHECK TIGHTNESS OF WEIGHT STACK LOCKING NUT. REPLACE CABLES ANNUALLY.	•	•
<b>UPHOLSTERY</b> WIPE DOWN AND DRY. CLEAN AND CONDITION.	•	•
<b>FRAME</b> WIPE WITH WATER DAMPENED CLOTH AND DRY COMPLETELY. POLISH AND WAX.	•	•
<b>CHROME</b> WIPE WITH WATER DAMPENED CLOTH AND DRY COMPLETELY. POLISH AND WAX.	•	•
<b>NUTS/BOLTS/FASTENERS</b> TIGHTEN AND/OR ADJUST AS NEEDED.		•
<b>GUIDE RODS</b> LUBRICATE AND CLEAN.		•
<b>ADJUSTMENTS/LOCKING PINS/TIGHTENING KNOBS</b>		•
<b>WEIGHT STACK PIN</b>		•
<b>WARNING/INSTRUCTION LABELS</b>		•
<b>ANTI-SKID GRIP TAPE</b>		•
<b>HAND GRIPS</b>		•



## **ST770 COMMERCIAL WARRANTY**

**COMMERCIAL USES DEFINED** VISION FITNESS warrants the ST770 model Bicep/Tricep for use in commercial facilities. Examples of commercial facilities include but are not limited to: Hotels; Resorts; Police and Fire Stations; Apartment Complexes; Rehabilitation and Sports Medicine Clinics; Hospitals; Elementary, Middle, and High Schools; YMCAs; Private Health Clubs; Colleges and Universities.

**FRAME, WELDS, WEIGHT PLATES, & GUIDE RODS - LIFETIME** VISION FITNESS warrants the Frame, Welds, Weight Plates and Guide Rods against defects in workmanship and materials for the life of the product, as long as it remains in the possession of the original owner.

**BUSHINGS, ROTATING BEARINGS, & PULLEYS - FIVE YEARS** VISION FITNESS warrants these components against defects in workmanship and materials for a period of five years from the date of original purchase, so long as the device remains in the possession of the original owner.

**CABLES, LINEAR BEARINGS, SHAFTS, & OTHER PARTS - ONE YEAR** VISION FITNESS warrants these components against defects in workmanship and materials for a period of one year from the date of original purchase, so long as the device remains in the possession of the original owner.

### **EXCLUSIVE REMEDY**

The exclusive remedy for any of the above warranties shall be repair or replacement of defective parts.

### **EXCLUSIONS AND LIMITATIONS**

This warranty applies only to the original owner and is not transferable. This warranty is expressly limited to the repair or replacement of a defective frame, electronic component, or defective part and is the sole remedy of the warranty. The warranty does not cover normal wear and tear, improper assembly or maintenance, or installation of parts or accessories not originally intended or compatible with the product as sold. This warranty does not cover failure to follow instructions and warnings in the Owner's Guide or failure to provide reasonable and necessary maintenance. This warranty does not apply to damage or failure due to accident, abuse, corrosion, discoloration of paint or plastic or neglect. VISION FITNESS shall not be responsible for incidental or consequential damages. Parts and electronic components reconditioned to As New Condition by VISION FITNESS or its vendors may sometimes be supplied as warranty replacement parts and constitute fulfillment of warranty terms. Any warranty replacement parts shall be warranted for the remainder of the original warranty term.

VISION FITNESS expressly disclaims all other warranties, express or implied, including but not limited to all warranties of fitness for a particular purpose or of merchantability. This warranty gives you specific rights and your rights may vary from state to state.

### **WARRANTY REGISTRATION**

Your warranty card must be completed and sent to VISION FITNESS before a warranty claim can be processed. You may also register via our website at [www.visionfitness.com](http://www.visionfitness.com). Inside the enclosed warranty card you will find a customer survey. Your care in completing the survey will be of value to us in serving you in the future. Comments and suggestions are always welcome. We are certain you will enjoy your new treadmill. Thank you for selecting a VISION FITNESS product.

\*ST770 Commercial Warranty valid in North America only

**Week #**

**Weekly Goals:** \_\_\_\_\_

**Scheduled Workout Time:** \_\_\_\_\_

**Reward:** \_\_\_\_\_

<b>Day</b>	<b>Date</b>	<b>Exercise</b>	<b>Sets</b>	<b>Reps</b>	<b>Weight</b>
<i>Sunday</i>					
<i>Monday</i>					
<i>Tuesday</i>					
<i>Wednesday</i>					
<i>Thursday</i>					
<i>Friday</i>					
<i>Saturday</i>					
<b>Totals</b>					

**Week #**

**Weekly Goals:** \_\_\_\_\_

**Scheduled Workout Time:** \_\_\_\_\_

**Reward:** \_\_\_\_\_

<b>Day</b>	<b>Date</b>	<b>Exercise</b>	<b>Sets</b>	<b>Reps</b>	<b>Weight</b>
<i>Sunday</i>					
<i>Monday</i>					
<i>Tuesday</i>					
<i>Wednesday</i>					
<i>Thursday</i>					
<i>Friday</i>					
<i>Saturday</i>					
<b>Totals</b>					

**Week #**

**Weekly Goals:** \_\_\_\_\_

**Scheduled Workout Time:** \_\_\_\_\_

**Reward:** \_\_\_\_\_

<i>Day</i>	<i>Date</i>	<i>Exercise</i>	<i>Sets</i>	<i>Reps</i>	<i>Weight</i>
<i>Sunday</i>					
<i>Monday</i>					
<i>Tuesday</i>					
<i>Wednesday</i>					
<i>Thursday</i>					
<i>Friday</i>					
<i>Saturday</i>					
<b>Totals</b>					

**Week #**

**Weekly Goals:** \_\_\_\_\_

**Scheduled Workout Time:** \_\_\_\_\_

**Reward:** \_\_\_\_\_

<i>Day</i>	<i>Date</i>	<i>Exercise</i>	<i>Sets</i>	<i>Reps</i>	<i>Weight</i>
<i>Sunday</i>					
<i>Monday</i>					
<i>Tuesday</i>					
<i>Wednesday</i>					
<i>Thursday</i>					
<i>Friday</i>					
<i>Saturday</i>					
<b>Totals</b>					

**Week #**

**Weekly Goals:** \_\_\_\_\_

**Scheduled Workout Time:** \_\_\_\_\_

**Reward:** \_\_\_\_\_

<b>Day</b>	<b>Date</b>	<b>Exercise</b>	<b>Sets</b>	<b>Reps</b>	<b>Weight</b>
Sunday					
Monday					
Tuesday					
Wednesday					
Thursday					
Friday					
Saturday					
<b>Totals</b>					

**Week #**

**Weekly Goals:** \_\_\_\_\_

**Scheduled Workout Time:** \_\_\_\_\_

**Reward:** \_\_\_\_\_

<b>Day</b>	<b>Date</b>	<b>Exercise</b>	<b>Sets</b>	<b>Reps</b>	<b>Weight</b>
Sunday					
Monday					
Tuesday					
Wednesday					
Thursday					
Friday					
Saturday					
<b>Totals</b>					

**Week #**

**Weekly Goals:** \_\_\_\_\_

**Scheduled Workout Time:** \_\_\_\_\_

**Reward:** \_\_\_\_\_

<b>Day</b>	<b>Date</b>	<b>Exercise</b>	<b>Sets</b>	<b>Reps</b>	<b>Weight</b>
Sunday					
Monday					
Tuesday					
Wednesday					
Thursday					
Friday					
Saturday					
<b>Totals</b>					

**Week #**

**Weekly Goals:** \_\_\_\_\_

**Scheduled Workout Time:** \_\_\_\_\_

**Reward:** \_\_\_\_\_

<b>Day</b>	<b>Date</b>	<b>Exercise</b>	<b>Sets</b>	<b>Reps</b>	<b>Weight</b>
Sunday					
Monday					
Tuesday					
Wednesday					
Thursday					
Friday					
Saturday					
<b>Totals</b>					





*it all  
starts  
with a  
v i s i o n*

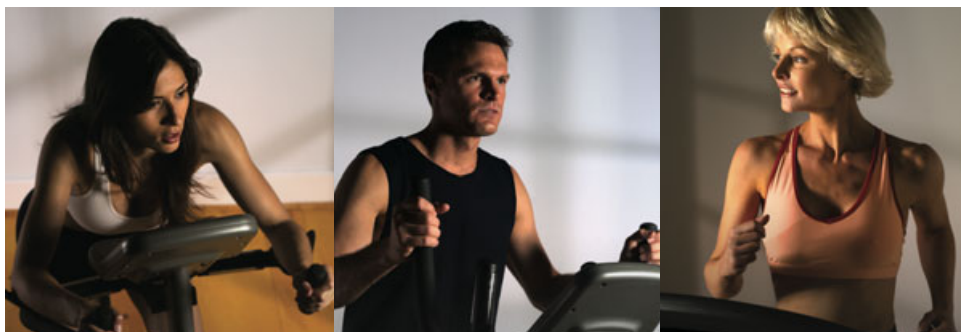

VISION  FITNESS®

500 South CP Avenue • P.O. Box 280 • Lake Mills, WI 53551  
toll free 800.335.4348 • phone 920.648.4090 • fax 920.648.3373  
[www.visionfitness.com](http://www.visionfitness.com)

©2007 Vision Fitness. All Rights Reserved. 2.07  
OM18.49PRD  
REV2